

MDF30EURO



CARATTERISTICHE:

Serrande tagliafuoco marchiate CE certificate UNI EN 15650, classificate secondo UNI EN 13501-3 e testate secondo UNI EN 1366/2. Installabili su condotte di aerazione garantiscono una rapida interruzione del flusso d'aria in caso di incendio. Possono essere attuate con servomotore, elettromagnete o fusibile termico a riarmo meccanico.

COSTRUZIONE:

Doppio involucro in acciaio zincato di forte spessore con taglio termico intermedio in fibrosilicato. Pala in fibrosilicato movimentata su perni di rotazione in acciaio alloggiati su boccole in ottone. Provviste di flangia esterna per connessione ai condotti e dispositivo di sgancio termico tarato di serie a 72 °C.

CONDIZIONI OPERATIVE:

Aria pulita, velocità massima 10 m/s.

CHARACTERISTICS:

Fire dampers marked CE certified UNI EN 15650, UNI EN 13501-3 classified and tested according to UNI EN 1366/2. Installable on ventilation ducts ensure a rapid interruption of the air flow in case of fire. May be implemented with servo motor, electromagnet or manual reset thermal fuse.

CONSTRUCTION:

Double casing in thick galvanized steel with thermal cut intermediate in calcium silicate. Blade in calcium silicate moved on pivots steel rotation housed on brass bushings. Provided with outer flange for connection to ducts have thermal release device calibrated standard at 72 °C.

OPERATING CONDITIONS:

Clean air, maximum air speed 10 m/s.

MDF30EUCEC

Serranda tagliafuoco con comando meccanico e predisposizione per elettromagnete
Fire damper with mechanical control and predisposition for electromagnet

PREZZI - PRICES

↑	BASE B mm									
	200	250	300	350	400	450	500	550	600	650
H mm	€	€	€	€	€	€	€	€	€	€
200										
250										
300										
350										
400										
450										
500										
550										
600										
650										
700										
750										
800										

↑	BASE B mm									
	700	750	800	850	900	950	1000	1050	1100	1150
H mm	€	€	€	€	€	€	€	€	€	€
200										
250										
300										
350										
400										
450										
500										
550										
600										
650										
700										
750										
800										

Nota: Nel prezzo sono inclusi 1 termofusibile 72°C e 1 microinterruttore.
Note: The price include 1 thermofuse 72°C and 1 electric microswitch.

↑	BASE B mm						
	1200	1250	1300	1350	1400	1450	1500
H mm	€	€	€	€	€	€	€
200							
250							
300							
350							
400							
450							
500							
550							
600							
650							
700							
750							
800							



Consigliato - Advised
MDF25 - MDF25L

MDF30EUCM

Serranda tagliafuoco con predisposizione per servomotore

Fire damper with predisposition for servomotor

PREZZI - PRICES

↑	BASE B mm									
	200	250	300	350	400	450	500	550	600	650
H mm	€	€	€	€	€	€	€	€	€	€
200										
250										
300										
350										
400										
450										
500										
550										
600										
650										
700										
750										
800										

↑	BASE B mm									
	700	750	800	850	900	950	1000	1050	1100	1150
H mm	€	€	€	€	€	€	€	€	€	€
200										
250										
300										
350										
400										
450										
500										
550										
600										
650										
700										
750										
800										

Nota: Nel prezzo sono inclusi 1 termofusibile 72°C e 1 microinterruttore.
 Note: The price include 1 thermofuse 72°C and 1 electric microswitch.

↑	BASE B mm						
	1200	1250	1300	1350	1400	1450	1500
H mm	€	€	€	€	€	€	€
200							
250							
300							
350							
400							
450							
500							
550							
600							
650							
700							
750							
800							

BFN
BF



Consigliato - Advised
MDF25 - MDF25L

DIMENSIONI - DIMENSION

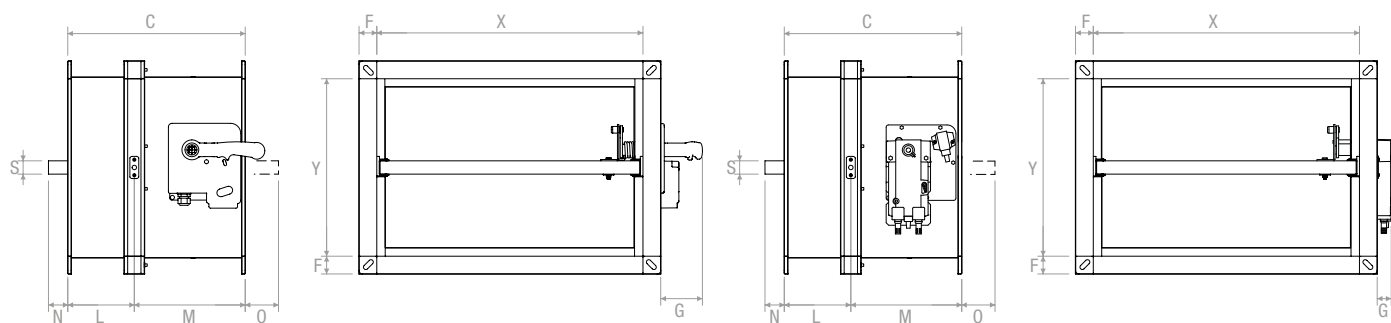

X	Y	C	L	M	F	G	N	O	S
B	H	400	150	250	40	95	H/2-155	H/2-255	30

X	Y	C	L	M	F	G	N	O	S
B	H	400	150	250	40	40	H/2-155	H/2-255	30

DIMENSIONE MASSIMA

Base: 2480 mm (nr. 2 serrande base 1200 mm passaggio aria)
Altezza: 800 mm

MAXIMUM SIZE

Base: 2480 mm (nr. 2 dampers base 1200 mm air passage)
Height: 800 mm

MDF30EURO
Installazione in batteria affiancata
Battery side by side installation

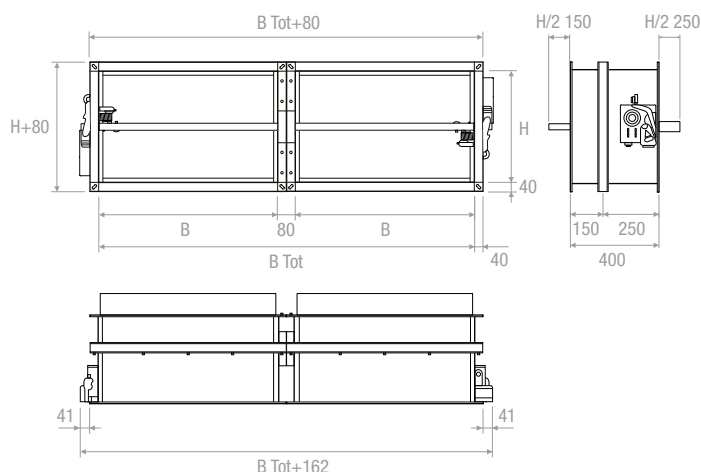

Le serrande per questa particolare installazione sono provviste di:

- Elementi termo-espandenti montati in fabbrica (necessario segnalare questa modalità di installazione in fase di ordine).
- Kit staffe di bloccaggio **KBTR** (nr. 4 staffe e nr. 16 viti auto-foranti) da ordinare unitamente alle serrande. Necessario 1 kit per ogni coppia di serrande affiancate.

The dampers for this particular installation are equipped with:

- Factory-mounted thermo-expansion elements (this must be reported when ordering is in place).
- **KBTR** Locking Bracket Kit (No. 4 Brackets and No 16 self-drilling screws) to be ordered together with the dampers. Necessary 1 kit for every couple of dampers to install side by side.
- **KS3** fixing bracket kit (4 brackets) to be ordered together with the dampers. Necessary 1 kit for every couple of dampers to install side by side.

TABELLA PRESTAZIONE - PERFORMANCE TABLE

SERRANDE TAGLIAFUOCO TESTATE SECONDO EN 1366-2 E CLASSIFICATE SECONDO EN 13501-3
 FIRE DAMPERS TESTED ACCORDING EN 1366/2 AND CLASSIFIED ACCORDING TO EN 13501-3

Classificazioni di resistenza - Classification of resistance		
	EI 120 S - 300 Pa	EI 90 S - 300 Pa
Muratura in calcestruzzo cellulare aerato spessore 150 mm Aerated concrete wall thickness 150 mm ($v_e \ i \leftrightarrow \ 0$)	da 200x200 a 1200x800 SR/M from 200x200 to 1200x800 SR/M	da 200x200 a 1200x800 SR/M from 200x200 to 1200x800 SR/M

Legenda

v_e = installazione verticale - vertical installation
 h_o = installazione orizzontale - horizontal installation
 $i \leftrightarrow \ 0$ = lato esposto al fuoco indifferente - side exposed to fire indifferent
 Pa = Pascal - Pascal

E = integrità - entirety
I = isolamento termico - thermal insulation
S = tenuta ai fumi - smoke seal
M = comando di riarmo manuale - manual reset device
SR = comando con servomotore - device with servomotor

Per installazione in batteria aggiungere 20% sul prezzo di ciascuna serranda + il prezzo di 1 kit KBTR + il prezzo di 1 kit KS3
 KBTR Kit staffe bloccaggio (nr. 4 staffe e nr. 16 viti auto-foranti) - KS3 Kit staffe fissaggio a muro (nr. 4 staffe)
 For battery installation add 20% on the price of each damper + the price of 1 KBTR kit + the price of 1 KS3 kit
 KBTR Locking bracket kit (4 brackets and 16 self-drilling screws) - KS3 Wall fixing bracket kit (4 brackets)

ACCESSORI - ACCESSORIES









	MODELLO - MODEL	DESCRIZIONE - DESCRIPTION	€
	FS3172	Termofusibile meccanico in rame 72°C Mechanical thermofuse in copper 72°C	
	FS31100	Termofusibile meccanico in rame 95°C Mechanical thermofuse in copper 95°C	
	ME40	Microinterruttore per segnalazione serranda "chiusa" o "aperta" Electric micro switch to signal damper "closed" or "open"	
	ME33	Elettromagnete con alimentazione 220V AC normalmente eccitato Electromagnet, main voltage 220V AC normally excited	
	MD34	Elettromagnete con alimentazione 220V AC normalmente diseccitato Electromagnet, main voltage 220V AC normally not excited	
	ME35	Elettromagnete con alimentazione 24V DC normalmente eccitato Electromagnet, main voltage 24V DC normally excited	
	MD36	Elettromagnete con alimentazione 24V DC normalmente diseccitato Electromagnet, main voltage 24V DC normally not excited	
	KS1	Kit staffe installazione a solaio (4 PZ) Brackets kit ceiling installation (4 PCS)	
	KS2	Kit staffe installazione parete leggera (4 PZ) Brackets kit light wall installation (4 PCS)	

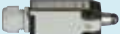

TABELLA PRESTAZIONE - PERFORMANCE TABLE

SERRANDE TAGLIAFUOCO TESTATE SECONDO EN 1366-2 E CLASSIFICATE SECONDO EN 13501-3
 FIRE DAMPERS TESTED ACCORDING EN 1366/2 AND CLASSIFIED ACCORDING TO EN 13501-3

Classificazioni di resistenza - Classification of resistance			
	EI 180 S - 300 Pa	EI 120 S - 300 Pa	EI 90 S - 300 Pa
Muratura in calcestruzzo cellulare aerato spessore 120 mm Aerated concrete wall thickness 120 mm $(v_e i \leftrightarrow o)$		da 200x200 a 1500x800 SR/M from 200x200 to 1500x800 SR/M	da 200x200 a 1500x800 SR/M from 200x200 to 1500x800 SR/M
Lastre in cartongesso tipo F spessore 125 mm Gypsum plasterboards type F wall thickness 125 mm $(v_e i \leftrightarrow o)$ necessario utilizzo kit staffe KS2 - need to use brackets kit KS2		da 200x200 a 1200x800 SR/M from 200x200 to 1200x800 SR/M	da 200x200 a 1200x800 SR/M from 200x200 to 1200x800 SR/M
Solaio in calcestruzzo armato spessore 150 mm Reinforced concrete slab thickness 150 mm $(h_o i \leftrightarrow o)$ necessario utilizzo kit staffe KS1 - need to use brackets kit KS1	da 200x200 a 1200x800 SR/M from 200x200 to 1200x800 SR/M	da 200x200 a 1200x800 SR/M from 200x200 to 1200x800 SR/M	da 200x200 a 1200x800 SR/M from 200x200 to 1200x800 SR/M

* Necessario utilizzo termoespandente LFC - Need to use thermo expanding gasket model LFC

Legenda

- v_e** = installazione verticale - vertical installation
 h_o = installazione orizzontale - horizontal installation
 $i \leftrightarrow o$ = lato esposto al fuoco indifferente - side exposed to fire indifferent
Pa = Pascal - Pascal
E = integrità - entirety
I = isolamento termico - thermal insulation
S = tenuta ai fumi - smoke seal
M = comando di riarmo manuale - manual reset device
SR = comando con servomotore - device with servomotor

MOTORI - MOTORS

BFN...-T CON TERMOFUSIBILE BAE72-S - WITH THERMOFUSE BAE72-S



CODICE - CODE	TENSIONE - VOLTAGE	COMANDO - COMMAND	€
BFN24T	24V	On-Off	
BFN24TST	24V	On-Off	
BFN230T	230V	On-Off	

Note

- tutti i BFN hanno N° 2 contatti di segnalazione finecorsa - all the BFN have 2 limit switch signal contacts
- le versioni BFN...ST hanno le spine preclabate per sistema SBS-Control - the BFN...ST version have a prewired plug for SBS control systems



BF...-T CON TERMOFUSIBILE BAE72-S - WITH THERMOFUSE BAE72-S



CODICE - CODE	TENSIONE - VOLTAGE	COMANDO - COMMAND	€
BF24TN	24V	On-Off	
BF230TN	230V	On-Off	

Note

- tutti i BF hanno N° 2 contatti di segnalazione finecorsa - all the BF have 2 limit switch signal contacts
- le versioni BF...ST hanno le spine preclabate per sistema SBS-Control - the BF...ST version have a prewired plug for SBS control systems

CODICE - CODE	DESCRIZIONE - DESCRIPTION	€
BKN23024 	Unità di alimentazione e comunicazione da installare sulla serranda tagliafuoco. Collegamento al quadro con linea a 2 poli. Supply and communications unit to be installed on the fire damper. Joined to the electric board by a 2-pole line.	
BKS241B 	Unità di controllo e comunicazione per una serranda da installare nel quadro di comando. Collegamento al BKN con linea a 2 poli. Control and communications unit for 1 damper to be installed on panel. Joined to the BKN by a 2 pole line.	
BKS249A 	Unità di controllo e comunicazione per gruppi fino a nove serrande, da installare nel quadro di comando. Collegamento ad ogni BKN con linea a 2 poli. Control and communications unit for groups of up to nine dampers, to be installed on Panel. Connected to each BKN by a 2-pole line.	

